



KONICA MINOLTA

bizhub PRESS C7000/C7000P/C6000

UNBEATABLE COLOR AND AFFORDABLE DIGITAL PRODUCTION:

GET THE
JOB DONE



HEAVYWEIGHT POWER

FOR PRINT PRODUCTION APPLICATIONS

Introducing a powerful trio of digital color presses that raise the bar in color quality, giving your print clients world-class imaging at up to 70 pages per minute in fast-paced production environments. The bizhub PRESS C7000 and C6000 are high-speed professionals with built-in copy/scan capabilities; the bizhub PRESS C7000P is a high-speed color printer you can count on to stay ahead of rising workloads. All three models combine higher quality, lower costs, and greater customer satisfaction.



Faster, more affordable high-quality color printing.

With Konica Minolta's bizhub PRESS C7000 and C6000 working for you, you'll have digital press performance with superior color output – the best color images in the production print marketplace. At up to 70 letter-size pages per minute (60 ppm with the bizhub PRESS C6000), you'll be able to deliver short-run color jobs to fit tight deadlines and tight budgets.

Create color presentations and reports. Corporate newsletters. Human resource documents. Stapled, hole-punched training manuals. Full-color saddle-stitched booklets and perfect-bound face-trimmed books, with precise front/back registration accuracy for images that align better across 2-page spreads. Plus color catalogs, sales materials, billing inserts and direct-mail flyers with variable data – digital capabilities that offset equipment can't match.

The bizhub PRESS C7000, C7000P and C6000 also help you work more cost-effectively. You'll eliminate the complex setup, make-ready and plate-change operations required by offset equipment. Your corporate and print-for-profit customers can even order print jobs via the Internet, saving time and speeding workflow.

A large 15" on-board touch-panel makes operation simple, even for personnel without special training. Print functions, finishing options and job handling commands are all at your fingertips, with enhanced operability and thumbnail image display that helps you Preview* jobs before you print.

Simitri HD toner: better color that's easier on the environment.

Konica Minolta's exclusive Simitri HD polymerized toner uses smaller, more uniform particles to reproduce ultra-fine image detail. In all three bizhub PRESS models, optimized 1,200 dpi print resolution achieves sharper lines, smoother graphics, and greater legibility. For added realism, advanced dot screen technology minimizes moiré and edge distortion. Outlines are sharpened to make color characters look thinner against white backgrounds and thicken the appearance of white knockout characters against color.

Another advantage of Simitri HD toner is its thinner core shell structure, requiring a lower fusing temperature than conventional toner particles. That allows faster print processing speed and increased image stability, a major benefit for production jobs demanding heavy paper stock. Simitri HD toner also creates a smoother printed surface that helps minimize friction, making it the ideal color carrier for both thick and thin paper. And it utilizes biomass, an organic resource that reduces environmental impact compared to conventional toners.



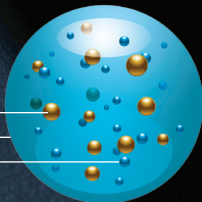

Wax
Thin-core Shell
Pigment

Simitri HD
High Definition Polymerized Toner

Simitri HD Toner:
the thin core
shell allows toner
particles to fuse
more quickly.

For a clean planet, count on Konica Minolta.

In addition to Simitri HD Toner with biomass, Konica Minolta incorporates more green technologies in every product – and offers every bizhub PRESS customer new ways to reduce pollution.

Our unique Clean Planet Recycling Program is Konica Minolta's cost-free recycling program for all consumables – toner cartridges, imaging units, waste toner bottles, developer and drums. High-volume production print users will have access to cost-free UPS return boxes, return postage labels printed from our website, even special delivery and pickup plans. We also reduce emissions, minimize pollutants and utilize recycled materials throughout our manufacturing process. We calculate and minimize the environmental impact of every bizhub PRESS product through its entire working life. And our Eco-Vision 2050 commitment aims to reduce CO2 emissions up to 20% by 2015 and 80% by 2050, sustaining the environment for generations to come.

ECO-VISION 2050 is Konica Minolta's commitment to protect the environment – saving energy, preserving resources, promoting recycling and reducing CO₂ emissions to help sustain the environment for generations to come. Please visit our website to learn more about our environmental initiatives and our exclusive Clean Planet Program. www.cleanplanetus.com



Toner type
TN616K

SPEED. EFFICIENCY. STABILITY.

FROM THE FIRST TO FINAL PRINT

The need for color is growing – and the pace of change demands new production tools that make high-quality color attainable and affordable. The bizhub PRESS C7000, C7000P and C6000 are heavyweight production professionals, designed to meet rising production needs in corporate, commercial and print-for-profit applications. Along with brilliant, natural image quality, you'll get color stability from first print to 5,000th – thanks to Konica Minolta technology innovations that improve both throughput speed and output quality.

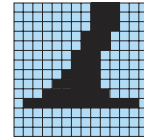
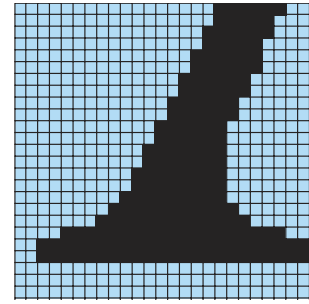

1200 DPI resolution:
greater image detail, finer lines, more legible characters – a bizhub PRESS goes far beyond the capabilities of conventional 600-DPI systems.

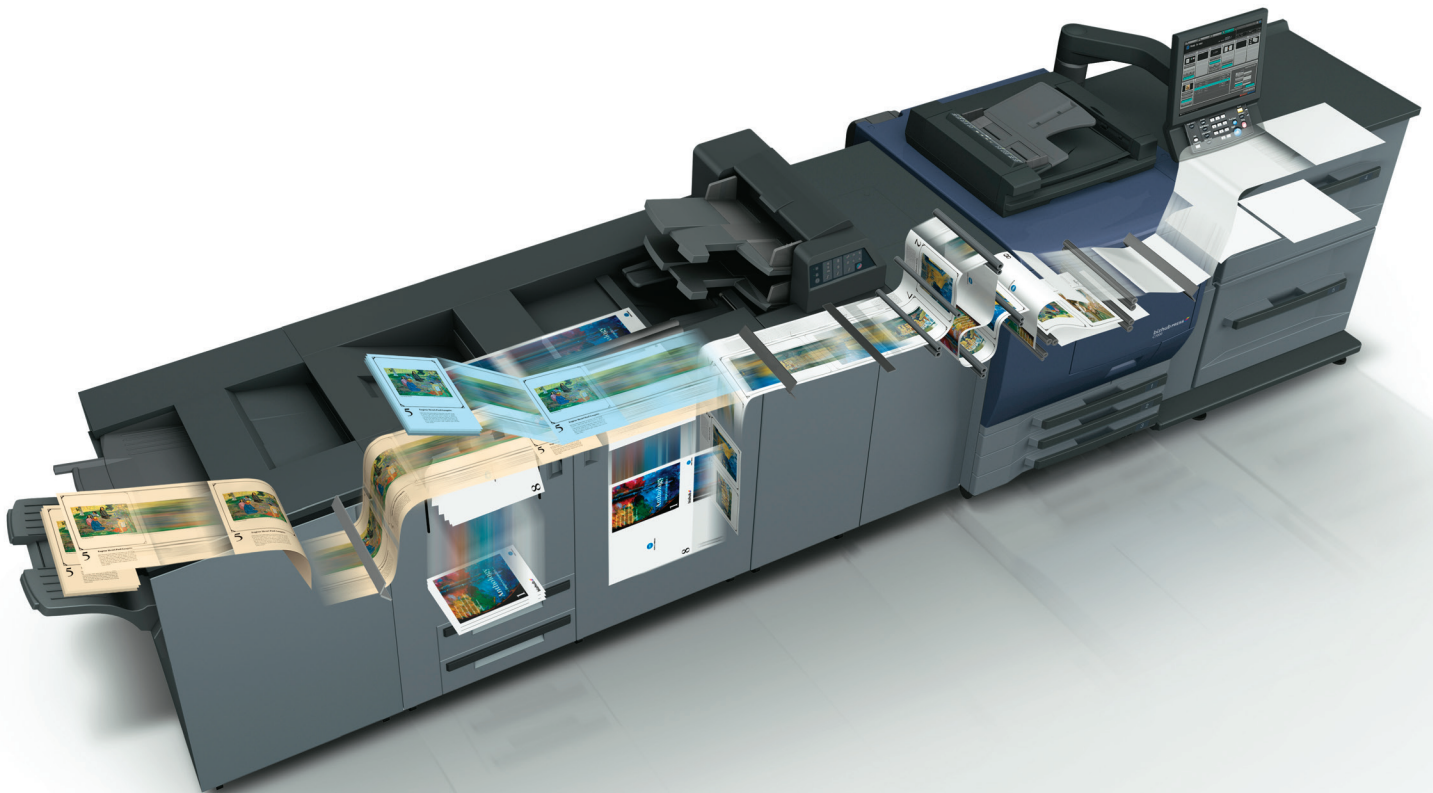



Outline Character Processing: reproduces the ideal thicknesses of knock-out type on color backgrounds.



Color Density Control: the CDC sensor reads printed color values to reproduce hues and skin tones more accurately on any paper stock.

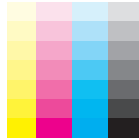
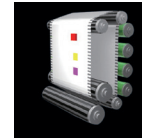

Image Density Control: the IDC sensor corrects halftone density automatically during continuous printing. Offering improved image stability from start to finish in any setup environment.



Purpose-built reliability to help keep work on schedule.

Rising demands won't wait for downtime – you've got to get the job done. To keep ahead of the pace, your bizhub PRESS C7000 and C7000P are designed for a maximum duty cycle up to 330,000 pages per month (C6000: 280,000 pages per month). All models use an advanced aluminum die-cast laser unit that writes information more accurately and maintains density more evenly. Its superior print-head design features a one-chip, eight-beam laser for pinpoint accuracy – and its color registration adjustment system can even calculate partial zoom errors.

The bizhub PRESS C7000 and C6000 also incorporate an advanced Screen-Enhancing Active Digital Processing (S.E.A.D. II) system that maintains color stability continuously and automatically. A Color Density Control (CDC) sensor provides real-time color density adjustment – correcting color gradations according to the paper stock being used, providing smooth gradations in high density and skin-tone areas and maintaining the same gradation on different types of paper.

An Image Density Control (IDC) sensor corrects density without slowing print speed and provides density balance adjustment mode for fine tuning. During continuous printing, the IDC sensor reads patches of magenta, yellow, cyan and black to adjust maximum density levels and correct half-tone density automatically. Image stability is also maintained over time and on different machines, so large-scale production plants can count on consistent output.

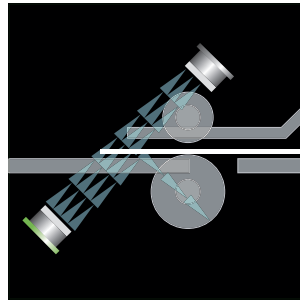

Multi-Feed Detection Sensors: ultrasonic sensors can detect multi-fed papers. If multi-feeding is detected, printing automatically stops to minimize misprints to prevent any blank sheets from getting mixed with the output.

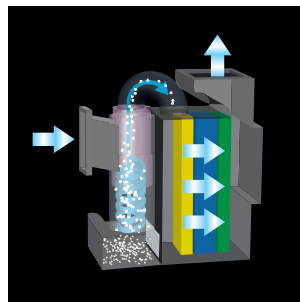

Cyclone Air Suction System: features a high-powered dust collector which collects 3 times more toner. Reducing the replacement frequencies of the filter unit to reduce machine downtime.

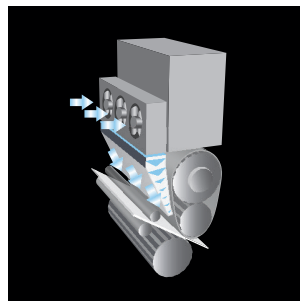

Air Blower Paper Separator: delivering air prevents the paper from wrapping around the upper fusing belt, thereby improving the reliability of the fusing unit's paper feeding.

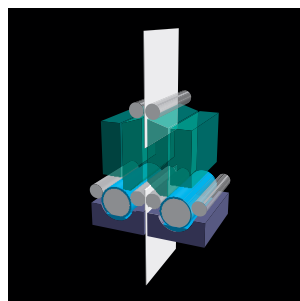

Hybrid Decurling Mechanism: humidifies the paper passage to remove unwanted static electricity and heat from the paper, as well as reduce paper curls and paper cling for highly accurate paper delivery.

Digital presses with unsurpassed media capabilities.

The right media for every job – and the ability to handle difficult paper sizes, weights and surfaces in any weather. To do it all, the bizhub PRESS C7000, C7000P and C6000 provide state-of-the-art technologies for maintaining high-speed output with smooth-running reliability.

A "Cyclone" vacuum system draws paper into the paper path for fail-safe uptake. An air-assist paper separation mechanism maximizes uptime with jam-free performance. And Hybrid Decurling combines advanced decurlers with an optional humidification system (HM-102) that provides just the right amount of moisture to the paper after printing. Uncoated stock can run more smoothly – and printed paper will cool more quickly as it moves to the relay unit, which has also been improved to achieve greater stability and maintain prefinishing conditioning over long press runs.

Along with reliable performance, these workhorse bizhub PRESS models are designed to achieve lower operating costs. Longer-life drum, developer, CMY and black toner help reduce total cost of ownership – another big advantage of bizhub PRESS technology.

POWERFUL PRINT FINISHING

THAT KEEPS YOU AHEAD OF SCHEDULE

The pressure is on. The needs of your next job may outstrip the capacity of legacy production systems. But no problem – because you can customize these bizhub PRESS production printers with a wide range of right-size configurations to get each job done quickly and cost-efficiently, minimizing labor that can slow down your output. With today's most comprehensive range of in-line finishing options, the bizhub PRESS C7000, C7000P and C6000 can boost your output – and benefit your bottom line.

Bringing your jobs across the finish line.

In all three bizhub PRESS models, open architecture allows internal processing and command systems to interface seamlessly with finishing components – in modular configurations that enable you to build a right-size system for any-size print production application.

The FD-503 Multi-Fold Punch Unit provides 2-hole/3-hole punching as well as six different folding functions: center-fold, letter fold-in, letter fold-out, double parallel fold, Z-fold, and gatefold. You can also use the FD-503 for paper insertion and manual-process folding and punching of preprinted documents.

The SD-506 Saddle-Stitch Unit lets you produce booklets up to 200 pages, with highly accurate saddle-stitching and trimming function. The FS-531 Staple Finisher provides automatic corner stapling and 2-point stapling of up to 50 sheets; the FS-521 offers 100-sheet stapling with 3,000-sheet capacity. The FS-612 Booklet Finisher creates center-fold booklets up to 80 pages as well as tri-fold and half-fold functions. Both the FS-612 and FS-531 also accept their own PK-512 Punch Kit and PI-502 Post Inserter options.

A powerful PB-503 Perfect Binder Unit can automatically finish bound books up to 600 pages, with precision paper and cover alignment for accurate perfect binding without the need for three-way trimming. And a sophisticated GBC Punch Unit (GP-501) provides simple slide-in, slide-out die replacement to accommodate the hole-punching style and configuration each production job demands.

Less reloading with 7,500-sheet paper capacity.

You can load all the paper you need for long unattended press runs that reduce labor costs – up to 7,500 sheets, in sizes up to 13" x 19" for oversized color spreads and proofs. You can add paper and change toner without interrupting your print run.

An optional LS-505 Large Capacity Stacker Unit handles up to 5,000 sheet output, with a rollaway cart that makes it easy to move print output to offline finishing or distribution points.

In addition, you can add a Hard Disk Kit (HD-514) and Preview Kit (PH-102) to your system for on-board document storage, recall and preview. With the bizhub PRESS C7000, C7000P and C6000, you'll have all the options – and that's what every business needs to stay competitive.



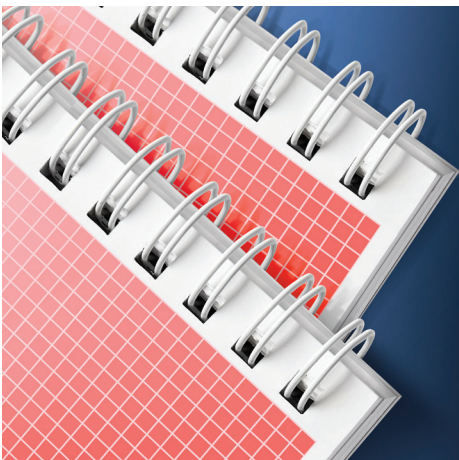
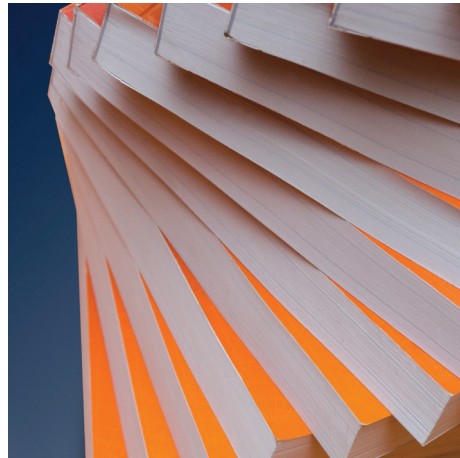

CENTER-FOLD



LETTER-FOLD IN



MULTI-LETTER-FOLD



MULTI CENTER-FOLD



PERFECT BINDING



2-POINT STAPLING



ONE-SIDED PRINTING



SHIFT SORTING



LETTER-FOLD OUT



GATE-FOLD



SADDLE STITCHING



COVER INSERTION



CORNER STAPLING



GBC PUNCHING



TRIMMING



STAPLE TRIMMING



DOUBLE PARALLEL



Z-FOLD



SHEET INSERTION



SHEET INSERTION (BOOKLET)



2-HOLE PUNCHING



DUPLEX PRINTING



TROLLEY STACKER



PERFECT BOUND STACKER

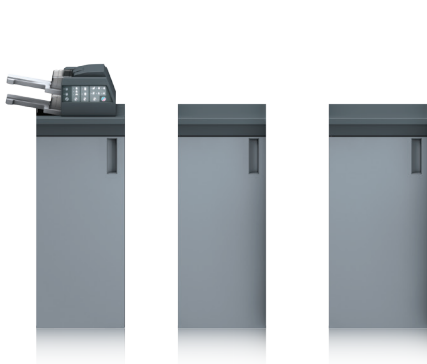

PROFESSIONAL PRINT CONTROL

FOR ANY PRODUCTION ENVIRONMENT

Color quality control. Print queue control. Production cost control. In today's networked environment, you need to maintain control over every aspect of your print production – with the flexibility to adapt to changing needs, accommodate existing processes and anticipate future demands. Along with superior image quality and high-speed performance, the bizhub PRESS C7000, C7000P and C6000 provide four sophisticated image control options – powerful print management capabilities to fit the fast-changing needs of your production floor.

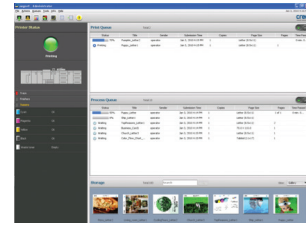

IC-307: Creo functionality with advanced color profiling.

The bizhub PRESS C7000, C7000P and C6000 will also accommodate the Creo® IC-307 External Print Controller, featuring advanced color profiling and destination profiles to spot colors, a complete Pantone GOE library, color sets and color print sets, an Easy VDP file creator, advanced perfect binder support, and full integration with Kodak print systems.

Office Hot Folder lets you print documents more quickly from remote locations. You'll also have Remote Site Manager status tracking, JDF connectivity, Creo color server and job ticket software, and much more.

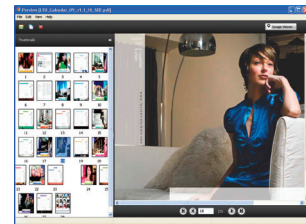

IC-306: state-of-the-art Fieri image control functions.

The IC-306 Fieri® Image Controller brings you the upgraded functions of Fieri System 9 and Fieri Driver 4.0 for both Windows and Mac environments.

Improved features of the IC-306 include Command WorkStation 5 interface with sophisticated color management tools, optional SeeSequence Suite that combines impose, compose and preview functions in one procedure, and extensive variable data printing support. You'll have hot folders, clone tool, job batching, force print, sample printing, and many more advanced functions for higher productivity.



IC-413: a Fiery internal controller for entry-level production.

EFI print controllers are hard at work in professional applications – and the IC-413 Fiery® Image Controller provides a unique combination of power and simplicity, with high performance, improved operability and upgraded functions. It supports 1200 dpi at up to 70 ppm, adopts the new Fiery System 9 for entry-level production environments, and shares a platform with proven legacy Fiery technology for stable quality.

This high-value, cost-effective print solution enables corporate and print-for-pay providers to satisfy clients who demand high-quality color with fast turnaround.

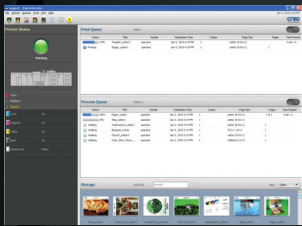

IC-601: a custom-designed internal controller.

The new Konica Minolta IC-601 Internal Print Controller is custom-designed, for in-house development that speeds support for market needs. It will bring powerful workflow benefits within reach of more print-for-pay and commercial printing applications – including 1,200 dpi printing at full rated engine speed, high-speed RIP processing and transfer between control and print engine, enhanced accuracy in CMYK color reproduction, and new color management functions, job control, editing functions, and remote operation capabilities.

The IC-601 will also support Konica Minolta's PageScope® software, for interactive, cost-effective control of documents and individual print devices – as well as the Printgroove Print-on-Demand Suite, combining multiple print management, workflow and job ticketing functions that give you automated control of your entire production floor.



AVAILABLE OPTIONS AND SPECIFICATIONS

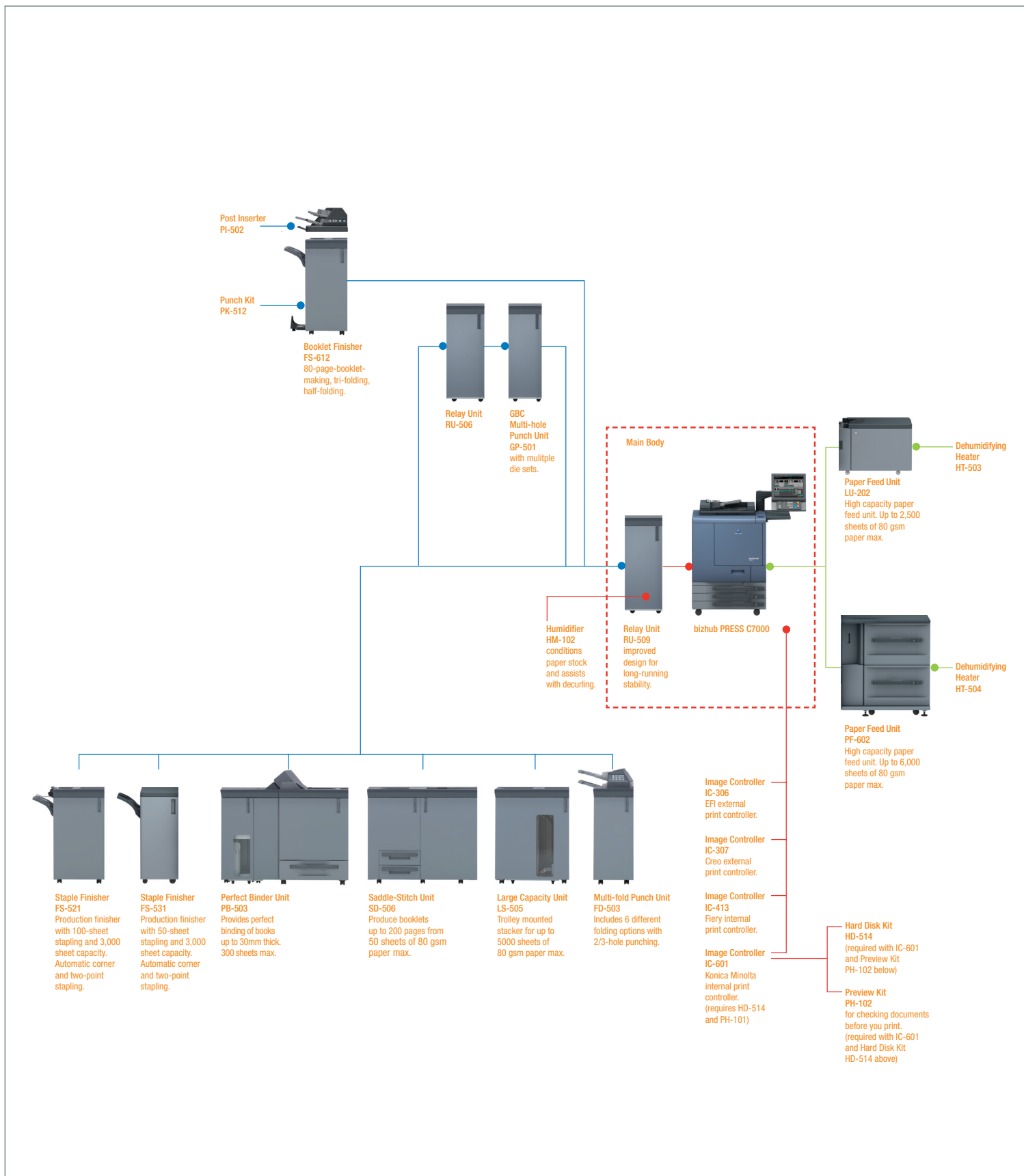



bizhub PRESS C7000



bizhub PRESS C6000

SPECIFICATIONS

Type	Console Type	
Print / Copy Process	Laser Electrostatic Transfer Method	
Development System	Dry Dual Component Magnetic Brush Development	
Print Speed / Monthly Duty Cycle	70ppm/330,000	60ppm / 280,000
Resolution / Gradation	1200 x 1200 dpi / 256 8-bit CMYK	
Standard Memory	384MB x 6 Standard	
Optional Memory	•160GB x 6 Optional	
Warm-up Time	Approx. 6.5 minutes	
Print / Copy Quantity	1-9,999 (Countdown, Interrupt Capability)	
Magnification	Zoom Range: 25%-400%	
• Original Size	Optional Reversing Duplexing Document Feeder: up to 11" x 17" maximum/100 Sheets/Mixed Original Detection	
Paper Size / Paper Weight	All trays: up to 13" x 19.2" maximum / up to 256 gsm; Tray 4 (LU-202) and Tray 5 (PF-602): up to 300 gsm	
Standard Paper Supply	500 Sheet Universal Paper Drawers x 3	
Maximum Paper Capacity	7,500 Sheets maximum	
Power Requirements (Engine)	208-240V, 60Hz, 22A Dedicated Line	
Dimensions (W x D x H)	29.9" x 39.1" x 42.3" (Engine only)	
Weight	785 lbs. (Engine only)	
Color Modes / Exposure Modes	Auto, Full Color, B&W, Single Color, Text, Text/Photo (Clear Text & Half-Tones), Photo Image, Map (Fine Edges, Text)	
Available Functions	Auto Zoom, Auto Paper Select, Auto Low Power, Auto Reset, Auto Shut Off, Color Mode, Combine Originals, Copy Density, Cover Sheet Feeding, Custom Size Paper Setting, Folding, Frame Center Erase, Image Centering, Image Repeat, Interrupt Copying, Job List, Manual Shut Off, Mode Memory, Non-Image Area Erase, Page Margin, Power Save, Proof Copy, Remote Monitor, Reserve Job, Rotation, Separate Scan Mode, Simplex, Duplex, Stamp, Staple, Tab Paper, Trimming, Weekly Timer, Z-Folded Original Setting, Zoom	
• Available Options	FS-612 Booklet Finisher, PK-512 Punch Kit, PI-502 Post Inserter, FD-503 Multi-Fold Punch Unit, SD-506 Saddle-Stitch Unit, LS-505 Large Capacity Stacker LC-501 Cart (for LS-505), FS-521 100-Sheet Staple Finisher, FS-531 50-Sheet Staple Finisher, PB-503 Perfect Binder Unit, RU-509 Relay Unit, HM-102 Paper Humidifier RU-506 Relay Unit (for GP-501), PF-602 6,000-Sheet Paper Feed Unit, LU-202 2,500-Sheet Paper Feed Unit, HT-503 Dehumidifier Heater (for LU-202), GP-501 GBC Multi-Hole Punch Unit, HD-514 HDD Unit (for IC-601), HT-504 Dehumidifier Heater for PF-602, PH-102 Preview Kit	
• IC-306 EXTERNAL FIERY IMAGE CONTROLLER (OPTIONAL)		
Operating System / Processor / Memory	Windows XP Pro FES / Intel® Core™ 2 Quad Q9400 2.66GHz Processors / 2GB RAM	
Hard Disk Drive / DVD Drive	160GB HDD / Internal DVD-RW Drive	
Software	Fiery System 9	
Networking Connectivity	Simultaneous Auto Switching Protocols, EtherTalk II, TCP/IP, Novell iPX iPrint, LDAP Support (Exchange, Novell, Domino, LDAPv3/RFC2251, Email Address Access and Authentication) User Password Validation, Certificate Management (SSL/TLS, X509 Standard), IP Sec Support, IPv6 Support	
File Format Support	Adobe® Postscript® Level 1, 2, 3, Adobe PDF 1.5 to 1.7 (Adobe Acrobat® 6 to 9), PDF/X-1a, 3 and 4, Encapsulated PostScript (EPS), MS Office (DOC, XLS, PPT, PUB (via Hot Folders)	
• Optional File Format Support	JPEG, DCS 2.0, CT/LW, 1-bit TIFF, TIFF, TIFF/IT, PDF2Go	
SNMP Printing Support	AppleTalk, Bonjour, SMB (peer-to-peer), LPD	
Performance Features	Fiery Smart RIP, RIP-While-Print, RIP 1-While-Print 2, Fiery RIPChips™, EFI Video Interface Card, ECT Compression (for flexible compression ratios and visually lossless image quality)	
Fiery Utilities	Fiery Driver, Fiery Command WorkStation 5, Fiery WebTools™, Fiery Hot Folders	
• Fiery Options	Fiery SeeSequence Suite, Fiery SeeSequence Impose, Fiery SeeSequence Compose, Fiery Graphic Arts Package (Premium Edition), Fiery Graphic Arts Package, ES-1000 Spectrophotometer, Fiery Color Profiler Suite, Removable Hard Disk Drive, Fiery Integrated Workstation: Fiery Stand, GUI Kit (19" Display, Keyboard, Mouse)	
• Optional Variable Data Handling	FreeForm™, PPML 2.2 (PDI certified), Creo VPS Compatible, Optimized PostScript® and Optimized PDF	
Power Supply	90-135VAC @ 47-63Hz, 6A @ 115VAC	
Dimensions (W x H x D)	8.3" x 19.2" x 19"	
• IC-307 EXTERNAL CREO IMAGE CONTROLLER (OPTIONAL)		
Operating System / Processor / Memory	Windows XP Professional Edition Embedded / Intel® Quad Core™ i7-860 3.46GHz, 8MB, Turbo Boost / 5GB RAM (System: 2GB, Image: 3GB)	
Hard Disk Drive / DVD Drive	1.5TB (System and User: 500GB, Image: 1TB) / DVD R/W	
Standard Hardware	Keyboard, Mouse and 19" Monitor	
• Optional Hardware	Creo Color Server product stand, X-Rite i1 Spectrophotometer	
Software Support	Adobe Acrobat 9.0 Standard, Enfocus, PitStop Acrobat Plug-in Lite Version 8	
Networking Connectivity	Ethernet 1000BASE-T/100BASE-TX/10BASE-T, TCP/IP, IPv4/IPv6, NetBEUI, AppleShare (File Sharing), PAP (File Printing), NetBIOS, 802.1x Authentication, PS, EPS, PDF1.8 (CPSI 3017), TIFF, JPEG (excluding progressive JPEG and JPEG2000), IPDS (Transaction Power Kit only)	
Page Description Language	PDF/X-1a, JDF1.3	
Hybrid Workflow	PPML 2.2, VPS (Creo Variable Print Specification 1.5)	
Variable Data Handling	PDF 9, ICC v4, Pantone GOE, FograCert, Adobe PDF Print Engine (APPE) 2, via a special software update	
Supported Print Standards	Destination Profiles to Spot Colors, Pantone GOE Library, Color Sets, Print Color Sets, Office Hot Folder Tool, Remote Site Manager, JDF 1.3 connectivity	
New Functions	Creo Color Server Job Ticket Software, Bi-directional Integration with Kodak Prinergy and Agfa Apogee, Easy VDP (Variable Data Printing), File Creator, Improved Perfect Binder Support	
• Optional Power Kits	Professional Power Kit, Process Power Kit, Imposition Power Kit, Transaction Power Kit	
Power Supply	100-127VAC @ 50-60Hz, 2A @ 100-127VAC	
Dimensions (W x H x D)	7.1" x 17.5" x 21.9"	
• IC-601 KONICA MINOLTA IMAGE CONTROLLER (OPTIONAL)		
System Version / Operating System	Konica Minolta 2.0 / TimeSys Linux 6.1	
Processor / Memory / Hard Disk Drive	Intel® Core™ 2 Duo 2.8GHz Processor / 4GB RAM / SATA: 500GB (250GB x 2), SSD: 2GB (Controller system stored)	
Engine I/F	Serial 768kbps, C7000 Series Video Clock (Print): 56.135MHz	
Page Description Language / PDF Support	Adobe® Postscript® 3™, CPSI 3019, TIFF, PCL5c/6, XPS / PDF v1.7, PDF/X-1a, PDF/X-3	
Variable Data Handling	PPML 2.1	
Font Support	Adobe Roman 136 fonts, PCL 81 fonts	
OS Support (Software)	Windows 2000, Windows XP, Windows Vista, Windows 2003 Server: PS (PPD, Visual), Windows Server 2008 7: PS (PPD, Visual), XPS, Mac OS X 10.4-10.6: PDE (Visual)	
Applications	PageScope Direct Print, PageScope EMS Plug-in, PageScope Web Connection, PageScope Account Manager, PageScope Net Care Device Manager, Net Backup Tool, Font Management Utility, Print Status Notifier, Print Utility for UNIX, Job Center (Job Control/Editing Utility), Color Centro (Color Management Utility), Printgroove POD QUEUE	
Power Supply	100-240V, 50-60Hz	
• IC-413 INTERNAL FIERY IMAGE CONTROLLER (OPTIONAL)		
Operating System / Processor / Memory	Windows XP Pro FES / Intel® E5300 2.6GHz Processor / 2GB RAM	
Hard Disk Drive / DVD Drive	160GB SATA / None	
Software	Fiery System 9	
Networking Connectivity	TCP/IP, AppleTalk, Point and Print, Bonjour support, Port 9100 (w/BiDi), IPP, FTP, SMB, Email client, Print via Email (PS/PDF), Network Time Protocol, IPv6 support	
Page Description Language	Adobe® Postscript® 3™, Enhanced PCL6 / PCL5	
Variable Data Handling	FreeForm™, Record & Set Level Finishing Support, VDP Record Range Printing, Define Record Length	
Security	Data Protection, Network Protection, User Authentication	
Fiery Utilities	Fiery Driver, Fiery Command Workstation 5, Fiery WebTools™, Fiery Hot Folders	

● OPTIONAL ● STANDARD

FOR ALL YOUR DOCUMENT NEEDS, COUNT ON KONICA MINOLTA



Konica Minolta Business Solutions U.S.A., Inc. is a leader in advanced document management technologies and IT Services. The company focuses on complete business solutions including production print systems, digital presses, multifunctional products (MFPs), managed print services, vertical application solutions and related services and supplies.

Konica Minolta has won numerous awards and recognition including being recognized as the #1 Brand for Customer Loyalty in the MFP Office Copier Market by Brand Keys for six years in a row. For the third consecutive year, Buyers Laboratory LLC (BLI) has named Konica Minolta as the winner of its "A3 MFP Line of the Year" award. In 2012, Konica Minolta also received "Document Imaging Solutions Line of the Year" recognition from BLI – and has been named to the Dow Jones Sustainability World Index in recognition of the company's economic, environmental and social performance.

We are proud of our record of achievement – and we invite you to learn first-hand why you can always count on Konica Minolta. For more information, visit: www.CountOnKonicaMinolta.com



KONICA MINOLTA

KONICA MINOLTA
BUSINESS SOLUTIONS U.S.A., INC.
100 Williams Drive
Ramsey, NJ 07446

www.CountOnKonicaMinolta.com
www.kmbs.konicaminolta.us

Konica Minolta Optimized Print Services offers a full suite of device output services and workflow solutions that increase efficiency and control costs. Please contact your authorized Konica Minolta sales representative for details.

Printed on a:
bizhub PRESS c8000

© 2013 KONICA MINOLTA BUSINESS SOLUTIONS U.S.A., INC. All rights reserved. Reproduction in whole or in part without written permission is prohibited. Konica Minolta and Count On Konica Minolta are registered trademarks of KONICA MINOLTA HOLDINGS, INC. bizhub and PageScope are trademarks of KONICA MINOLTA BUSINESS TECHNOLOGIES, INC. Simitri is a registered trademark of KONICA MINOLTA BUSINESS SOLUTIONS. Fiery is a trademark of EFI. Creo is a trademark of Creo. All other brands and product names are registered trademarks or trademarks of their respective owners. Design & specifications are subject to change without notice. Some functions may require options, which may or may not be available at time of launch.

bizhub PRESS

Simitri
with Biomass

PageScope
SOFTWARE

bizhub care

SEAR

efi

creo

Windows
System

Microsoft
Office

Microsoft
Office

Microsoft
Office

Mac

Item #: C7000BRO
3/13